

### ECONOMIZER 101

Economizers are designed to provide “free” air conditioning when outside conditions are appropriate. When the outside air is cool and dry enough, the economizer automatically opens to introduce the cool air to the interior space, thereby eliminating the need to run the air conditioning compressor.

If the outside air becomes too warm or humid, the economizer automatically closes the fresh air damper and the compressor engages to begin cooling the space mechanically.

If a two stage thermostat is used it is possible to use a combination of economizer and mechanical cooling to condition the space.

The economizer can also be set to allow a minimum amount of fresh air to enter the space when the equipment’s indoor blower is operating.

Economizers are valuable tools to enhance indoor air quality, save energy and prolong the life of the air conditioning equipment.

### SEQUENCE OF OPERATION

This sequence assumes employment of a single enthalpy economizer using a two stage thermostat.

1. A call for cooling comes from room thermostat.
2. The enthalpy sensor determines if the atmospheric conditions are conducive for using outside air for cooling. If YES, go to step 3. If NO, or if outdoor air temperature rises above enthalpy set point, go to step 4.
3. The outside air dampers open and modulate to maintain a mixed air temperature (outside air + indoor air) of 53 degrees F. If the outdoor air is insufficient to satisfy the thermostat alone and a second stage of cooling is required, the compressor starts and works in conjunction with the economizer

to cool the space. In a system with two compressors, if the thermostat is still not satisfied by the economizer and stage 1 compressor, the Jade control will energize the second compressor. (Go to step 5.)

4. Outdoor air dampers open to minimum position and the compressor engages to provide mechanical cooling.
5. When the thermostat is satisfied the outside air dampers return to a minimum position.

### INSTALLATION

1. Open carton and inspect contents for shortages and damage.
2. Disconnect power to the package unit.
3. Remove large evaporator access panel from package unit.
4. Remove the horizontal duct opening cover.
5. Remove the downflow return air panel inside of the unit.
6. Install the internal damper rack over the downflow return air opening.
7. Attach the external hood/damper assembly to the side of the unit using screws removed in step 3. (Figure 1)

**NOTE:** Ensure that the wires do not interfere with either the fresh air or return air damper operation. The wires should not be pinched between the fresh air hood and the unit or the return air dampers and the base pan.

8. Plug the economizer harness into the jumper harness economizer plug in the unit.
9. Connect the damper rod from the internal damper rack to the fresh air dampers.
10. Feed the pink mixed air sensor wire into the blower section of the unit and secure the mixed air sensor to the side of the blower toward the outer edge of the housing. (Figure 2)
11. Connect the pink wires to the mixed air sensor and the Jade economizer control. (Figure 3)
12. Install the top block off panel/filter access with the screws provided.
13. Restore power to the unit.
14. Attach the horizontal duct opening cover.
15. Determine the minimum position setting using the minimum set point equation on page two.
16. Seal connection between the fresh air hood and unit until water tight.
17. Install Goodman IRKT-01 Isolation Relay Kit for heat pumps per the instructions included with the IRKT-01.

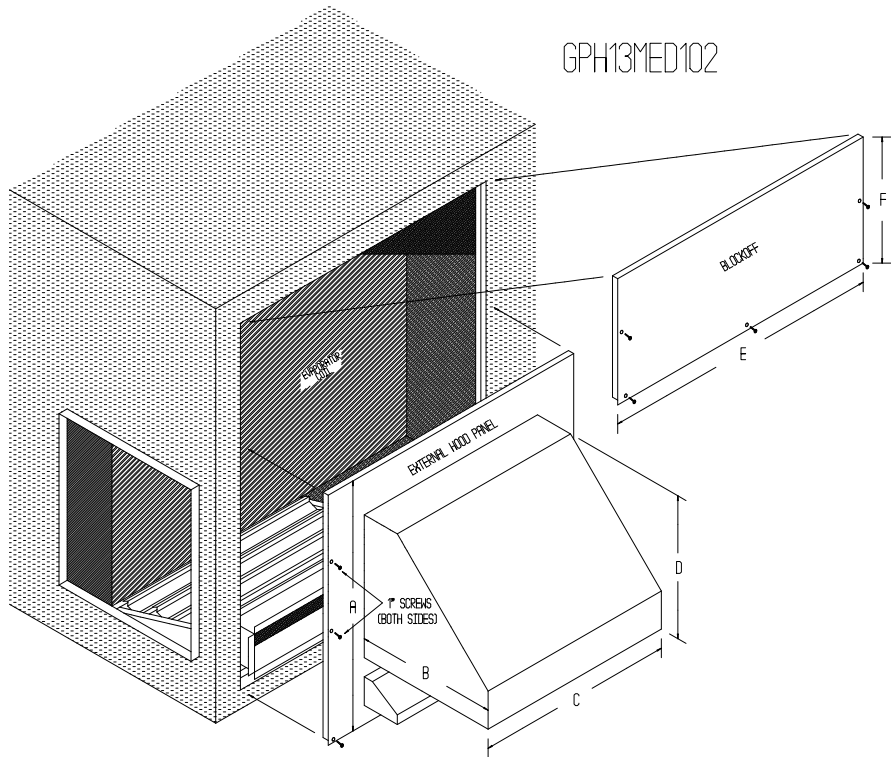

Figure 1

	A	B	C	D	E	F
GPJMED102	23 1/2	15	21 1/4	15	29 3/4	8 3/8

### CONTENTS

1	Damper rack w/ economizer controls
1	Hood Assembly
1	Fresh Air Mist Eliminator
1	Top Panel
1	Installation/Component Manual
1	Mixed Air Sensor

### ACCESSORIES / CAPABILITIES

Dual Enthalpy - Requires an additional C7400 enthalpy control installed in the return air duct.

Demand Control Ventilation - Requires a CO2 sensor.

IRKT-01 Isolation relay kit is required for heat pump applications

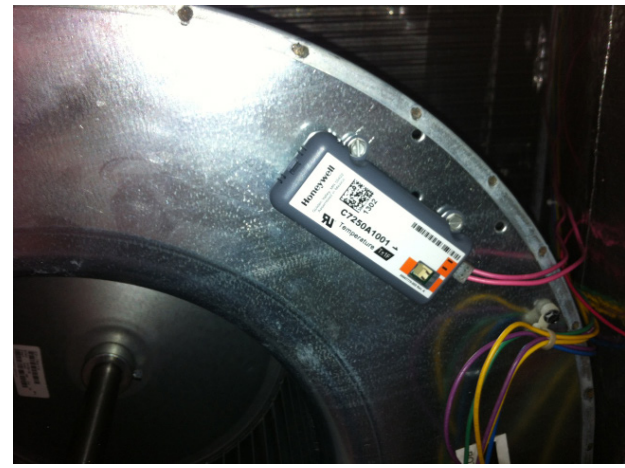

Figure 2



Figure 3

The equation below may be used to set the minimum position. The mixed air temperature and outside air temperature may be discerned by looking at the status menu on the Jade controller.

### MINIMUM SET POINT EQUATION

$$(To \times OA) + (Tr \times RA) = Tm$$

**To = Outdoor air temperature**

**OA= Percent of outdoor air**

**Tr = Return air temperature**

**RA= Percent of return air**

**Tm= Resulting mixed air temperature**

#### Example:

Fresh air required is 10% outdoor air.

Outdoor air temperature is 60 degrees F.

Return air temperature is 75 degrees F.

$$(0.1 \times 60) + (0.9 \times 75) =$$

$$6.0 + 67.5 = 73.5$$

Mixed air temperature will be 73.5 degrees F when the OA is 60 degrees F and the RA is 75 degrees F with 10% outdoor air.

# Important Notes

- Please see enclosed brochure for Honeywell component trouble shooting instructions as well as instructions for heat pump set up.
- Heat pump applications require Goodman part number IRKT-01 isolation relay kit.
- The fresh air mist eliminator should be flushed periodically with warm soapy water.
- A two stage thermostat is recommended with this accessory.

# JADE WIRE DIAGRAM 3105 REV4

GROUND

GROUND LUG

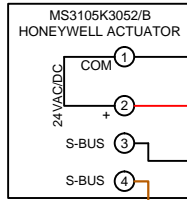

BLACK  
RED  
WHITE  
BROWN

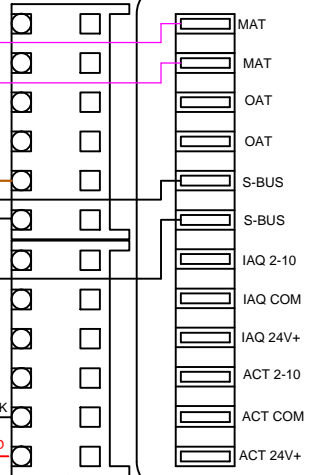

PINK  
PINK  
WHITE  
WHITE  
BLACK  
RED

HONEYWELL  
W720

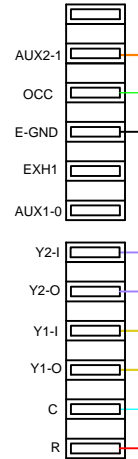

(O)  
BLACK  
(P)  
(P)  
(Y)  
(Y)  
(BL)  
(R)

MOLEX 3597706\*\*  
50048926-002

CONNECT TO  
C7400S1000  
ENTHALPY CONTROL

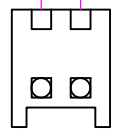

CONNECT TO  
C7250A1001  
MIXED AIR SENSOR

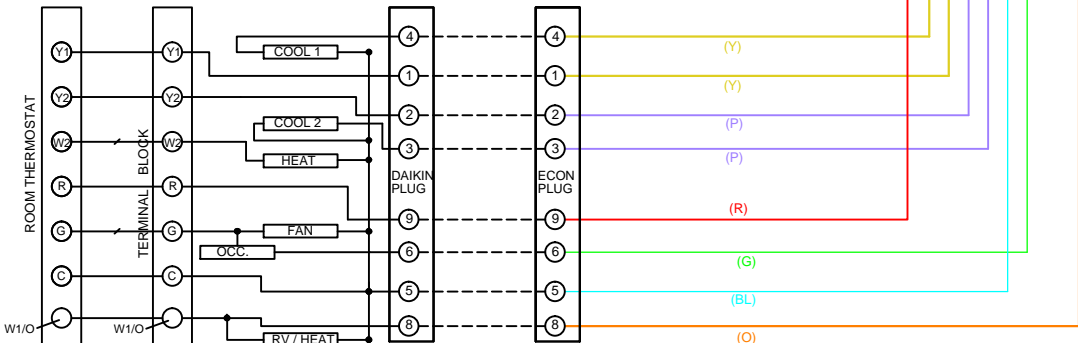

COLOR CODES FOR 9 PIN PLUG

- ① (Y) YELLOW
- ② (P) PURPLE
- ③ (P) PURPLE
- ④ (Y) YELLOW
- ⑤ (BL) BLUE
- ⑥ (G) GREEN
- ⑧ (O) ORANGE
- ⑨ (R) RED

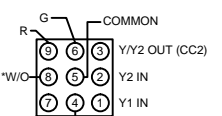

\* WHITE WIRE ON DCG  
ORANGE WIRE ON DCH